

User Manual

MasterPower[®]
Unlimited power



Mobile Power Station MF-MPS-1.2K / MF-MPS-2.5K

Table Of Contents

1. SAFETY INSTRUCTIONS	1
2. INTRODUCTION	2
Features	2
Packing Contents	3
Product Overview	3
3. INSTALLATION	4
Installation warning and warranty coverage	4
PV Module Connection	4
AC Input Connection	6
AC Output Connection	6
4. OPERATION	7
Power ON/OFF	7
Battery BMS ON/OFF	7
Operation and Display Panel	7
LCD Display Icons	8
LCD Setting	10
Display Setting	13
Operating Mode Description	16
Fault Reference Code	18
Warning Indicator	19
5. CLEARANCE AND MAINTENANCE FOR ANTI-DUST KIT	20
Overview	20
Clearance and Maintenance	20
6. SPECIFICATIONS	21
Table 1 Line Mode Specifications	21
Table 2 Inverter Mode Specifications	22
Table 3 Battery Specifications	22
Table 4 Charge Mode Specifications	23
Table 5 USB Output Specifications	23
Table 6 General Specifications	23
7. TROUBLE SHOOTING	24

Thank you for purchasing this mobile power station product. Please read this manual carefully before installations and operations. Keep this manual for future reference.

1. SAFETY INSTRUCTIONS



WARNING: This chapter contains important safety and operating instructions. Read and keep this manual for future reference.

- 1) It is very important and necessary to read the user manual carefully before using the unit. Failure to do so or to follow any of the instructions or warnings in this document can result in electrical shock, serious injury, or death, or can damage the unit, potentially rendering it inoperable.
- 2) Do not disassemble the unit. Take it to a qualified service center when service or repair is required. Incorrect re-assembly may result in a risk of electric shock or fire.
- 3) If the battery is stored for a long time, it is required to charge them every six months, and the SOC should be no less than 90%.
- 4) Battery needs to be recharged as soon as possible after fully discharged.
- 5) Do not expose battery to flammable or harsh chemicals or vapors.
- 6) Do not use cleaning solvents to clean the battery.
- 7) Keep the battery away from water and fire.
- 8) **WARNING:** Only qualified service persons are able to service this device. If errors still persist after following troubleshooting table, please send this unit back to local dealer or service center for maintenance.
- 9) **WARNING:** Because this unit is non-isolated, only three types of PV modules are acceptable: single crystalline, poly crystalline with class A-rated and CIGS modules. To avoid any malfunction, do not connect any PV modules with possible current leakage to the unit. For example, grounded PV modules will cause current leakage to the unit. When using CIGS modules, please be sure NO grounding.
- 10) **CAUTION:** It's requested to use PV junction box with surge protection. Otherwise, it will cause damage on the unit when lightning occurs on PV modules.

2. INTRODUCTION

This is a mobile power station for home and adventure. The power stations have a battery, inverter and smart charging technology all built into a neat plug and play unit. Plug and Play off-grid system provides multiple charging options, giving you the flexibility to charge from AC (wall outlet or generator) and solar panel. All units are provided multiple power sockets and USB charger ports, allowing to power your diverse electronic devices.

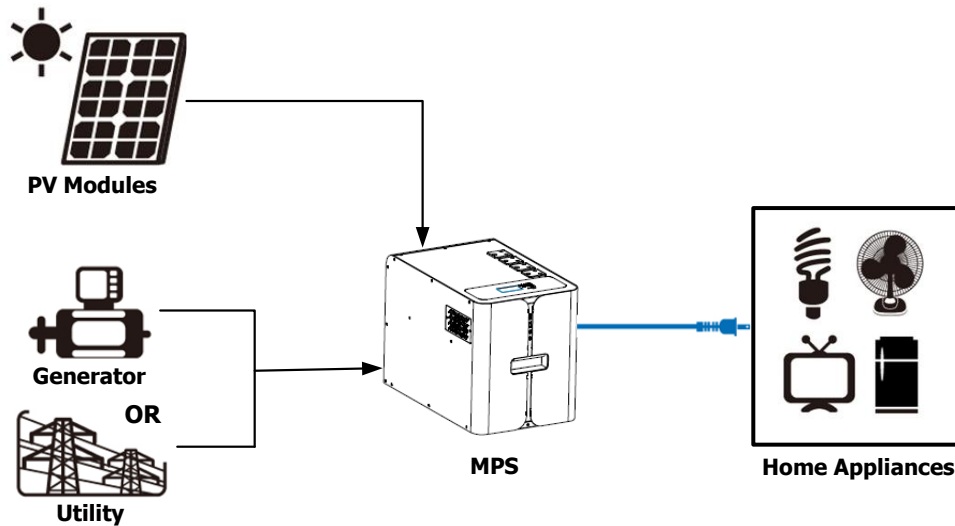

Features

- Pure sine wave output
- Built-in BMS communication port
- Built-in anti-dust kit
- Configurable input voltage range for home appliances and personal computers via LCD setting
- Configurable battery charging current based on applications via LCD setting
- Configurable AC/Solar Charger priority via LCD setting
- Compatible to mains voltage or generator power
- Overload/ Over temperature/ short circuit protection
- Suitable for portable outdoor applications

Packing Contents

Before installation, please inspect the unit. Be sure that nothing inside the package is damaged during transportation. Do not turn on the unit and notify the carrier and dealer immediately if there is any damage or lacking of some parts. Please keep the original package in a safe place for future use.

You should have received the following items inside of package:

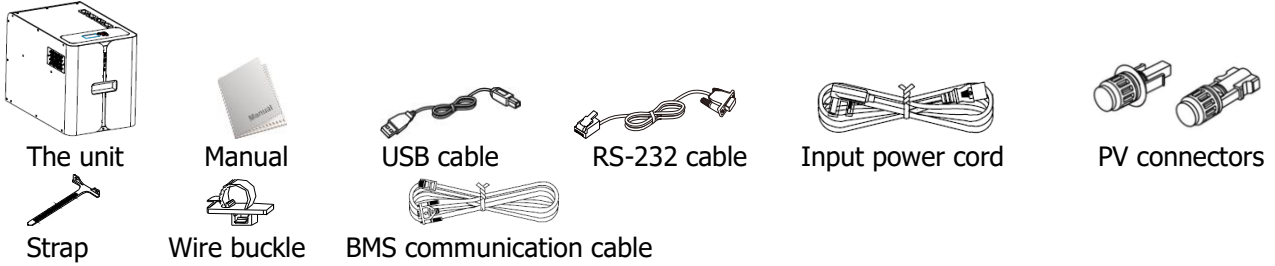

Product Overview

Top view

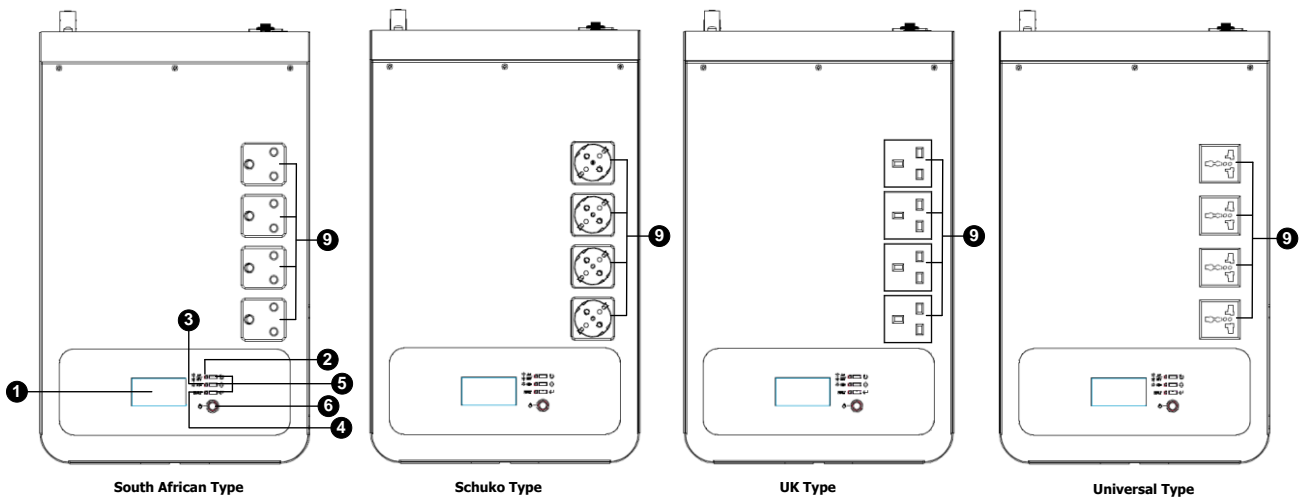

Front panel and Rear panel

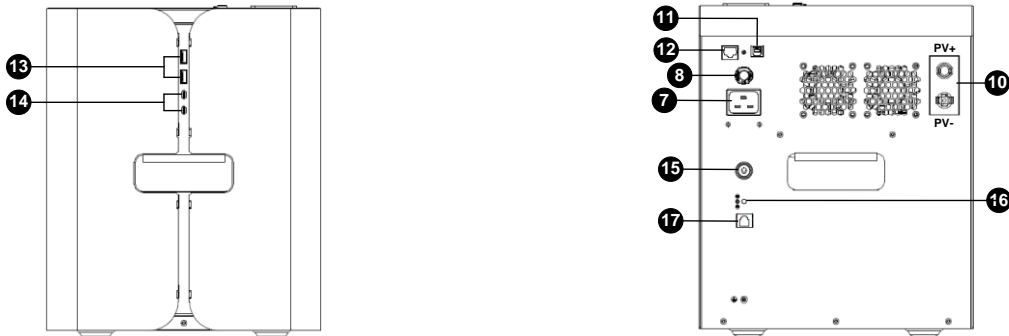

- | | |
|--------------------------|-------------------------------|
| 1. LCD display | 10. PV MC4 connectors |
| 2. Status indicator | 11. USB communication port |
| 3. Charging indicator | 12. RS-232 communication port |
| 4. Fault indicator | 13. Type-A USB output |
| 5. Function buttons | 14. Type-C USB output |
| 6. Power ON/OFF switch | 15. BMS switch |
| 7. AC input receptacles | 16. BMS status indicator |
| 8. Input circuit breaker | 17. BMS communication port |
| 9. AC output sockets | |

3.INSTALLATION

Installation warning and warranty coverage

In order to be able to enjoy a quality photovoltaic installation with all guarantees, it is a requirement that the installation be carried out by a qualified professional. All the components of the installation must be connected and installed by a qualified professional as a requirement for any product defect in its manufacture to be covered by the warranty. The qualified professional must have the low voltage electrical installer's license and the installation must be carried out in accordance with the Low Voltage Electrotechnical Regulations (REBT) as well as any other applicable regulations.

Those components that have been installed without the protection devices and/or without the cable sections in accordance with the REBT will not be covered by the warranty. Components that have been uninstalled without prior remote technical verification by the supplier or that have been uninstalled by unqualified personnel are not covered by the warranty. The warranty does not cover devices that show that the warranty seal has been tampered with or removed will not be covered by the warranty.

Unpacking and Inspection

Before installation, please inspect the unit. Be sure that nothing inside the package is damaged. You should have received the following items inside of package:

PV Module Connection

CAUTION: Before connecting to PV modules, please install separately a DC circuit breaker between inverter and PV modules.

NOTE1: Please use 600VDC/30A circuit breaker.

NOTE2: The overvoltage category of the PV input is II.

WARNING: Because this inverter is non-isolated, only three types of PV modules are acceptable: single crystalline and poly crystalline with class A-rated and CIGS modules.

To avoid any malfunction, do not connect any PV modules with possible current leakage to the inverter. For example, grounded PV modules will cause current leakage to the inverter. When using CIGS modules, please be sure NO grounding.

CAUTION: It's requested to use PV junction box with surge protection. Otherwise, it will cause damage on inverter when lightning occurs on PV modules.

Please follow the steps below to implement PV module connection:

Step 1: Check the input voltage of PV array modules. The selected PV modules should be within following parameters.





MODEL	1.2KW	2.5KW
Max. PV Array Open Circuit Voltage	350Vdc	450Vdc
PV Array MPPT Voltage Range	60~300Vdc	60~400Vdc

CAUTION: Exceeding the maximum input voltage can destroy the unit!! Check the system before wire connection.

Step 2: Disconnect the AC input circuit breaker and BMS switch OFF to keep the unit completely OFF.

Step 3: Assemble provided PV connectors with PV modules by the following steps.

Components for PV connectors and Tools:

Female connector housing	
Female terminal	
Male connector housing	
Male terminal	
Crimping tool and spanner	

Prepare the cable and follow the connector assembly process:

Strip one cable 8 mm on both end sides and be careful NOT to nick conductors.

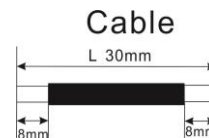

Insert striped cable into female terminal and crimp female terminal as shown below.



Insert assembled cable into female connector housing as shown below.

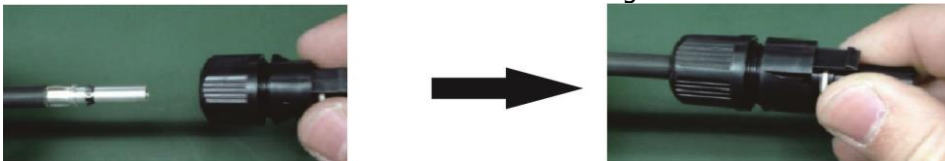

Insert striped cable into male terminal and crimp male terminal as shown below.



Insert assembled cable into male connector housing as shown below.

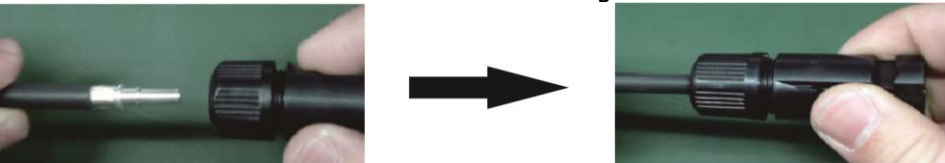

Then, use spanner to screw pressure dome tightly to female connector and male connector as shown below.



Step 4: Check the correctness of the polarity of connection cable on PV modules and PV input connectors. Then, connect positive pole (+) of connection cable to positive pole (+) of PV input connector. Connect negative pole (-) of connection cable to negative pole (-) of PV input connector.

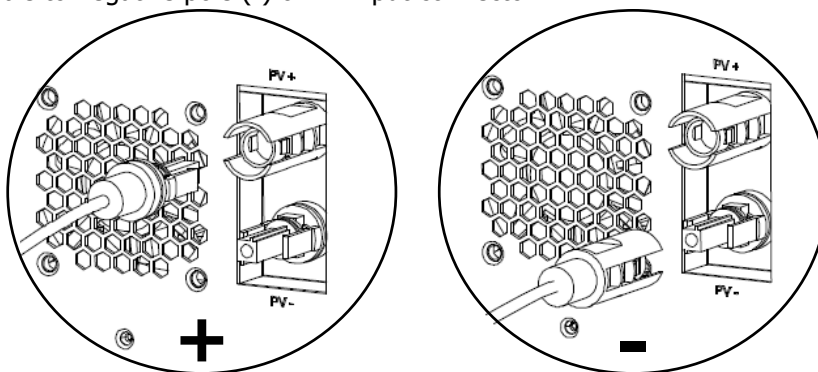

WARNING! For safety and efficiency, it's very important to use appropriate cables for PV module connection. To reduce risk of injury, please use the proper cable size as recommended below.

Conductor cross-section (mm ²)	AWG no.
4	10

CAUTION: Never directly touch the terminals of unit. It might cause lethal electric shock.

Recommended Panel Configuration:

Solar Panel Spec. (reference)	SOLAR INPUT		VOC	Q'ty of panels	Total input power
	(Min in serial: 3 pcs, max. in serial: 10 pcs)				
- 350Wp	3 pcs in serial		132VDC	3 pcs	1050W
- Vmp: 35Vdc	6 pcs in serial		264VDC	6 pcs	2100W
- Imp: 10A	8 pcs in serial (Only for 2.5KW model)		352VDC	8 pcs	2800W
- Voc: 44Vdc	10 pcs in serial (Only for 2.5KW model)		440VDC	10 pcs	3500W
- Isc: 11A					

AC Input Connection

Follow below steps to plug in the input power cord (supplied in the package) to the wall outlet. The unit will automatically charge the connected internal battery pack even though the unit is off.

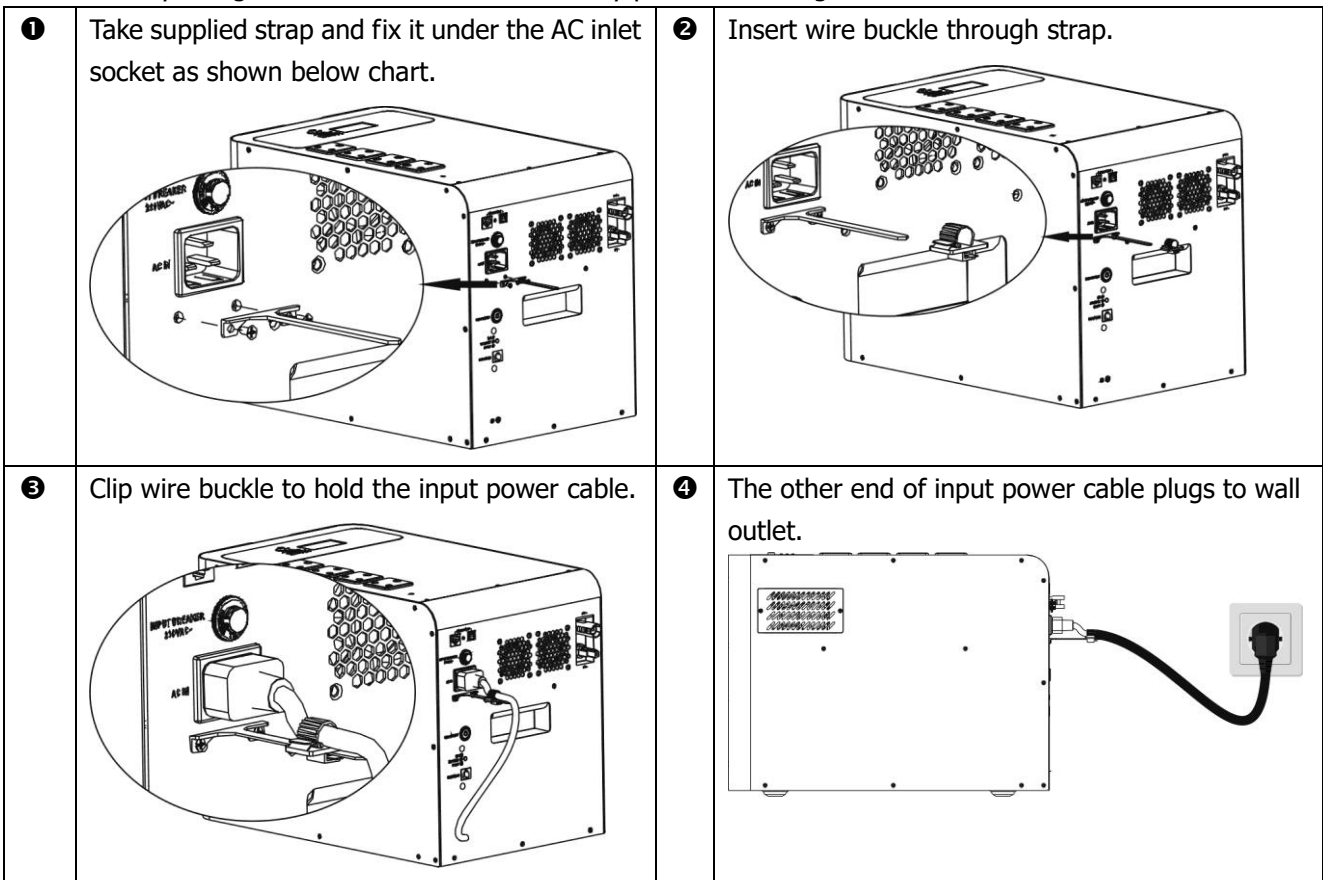

* Suggest to connect PE protective conductor (⊕) first before AC input connection.

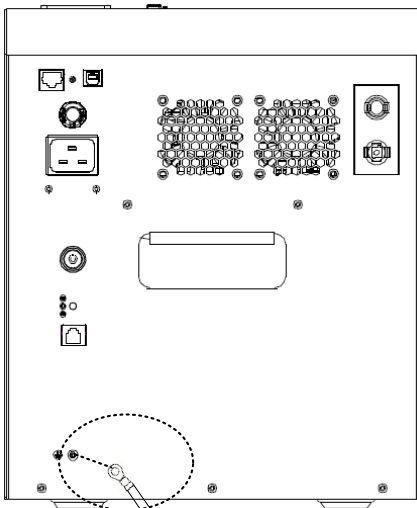

AC Output Connection

This unit is equipped with four output sockets. Simply plug equipment to the AC output sockets.

4. OPERATION

Power ON/OFF

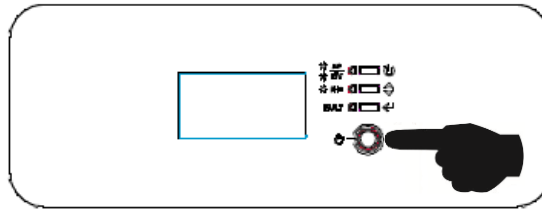

Press On/Off switch on the top of the case to turn on the unit. At this time, the unit will have AC output power. If only requires the USB port with DC output, you can turn off the inverter to save the power consumption and extend the backup time for the USB port.

Battery BMS ON/OFF

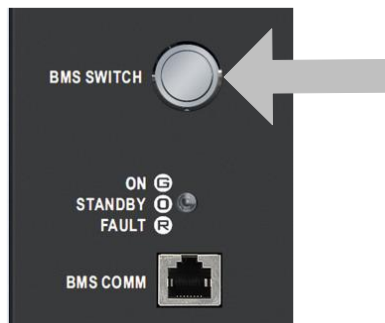

BMS switch is to wake up or shut down the battery module inside the unit.

- If battery module is off, press and hold the button (located in the rear panel of the unit) over 5 seconds to turn on the battery module.
- If battery module is working, press and hold the button for 5 seconds to shut down the battery module.

* If the unit is connected with either AC or PV inputs, the unit will wake up the internal BMS automatically, no need to press this BMS ON/OFF button.

Battery Status LEDs: Indicates battery module status.



LED Color	Battery Status	Messages
Green	On	There is output from battery module.
Orange	Standby	BMS is working but no output from battery
Red	Fault	Fault condition in battery module.

Operation and Display Panel

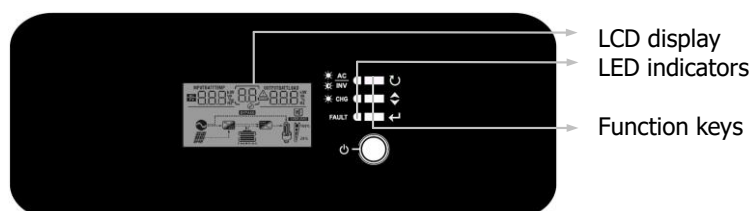

The operation and display panel, shown in below chart, is on the top of the unit. It includes three indicators, three function keys and a LCD display, indicating the operating status and input/output power information.



LED Indicator







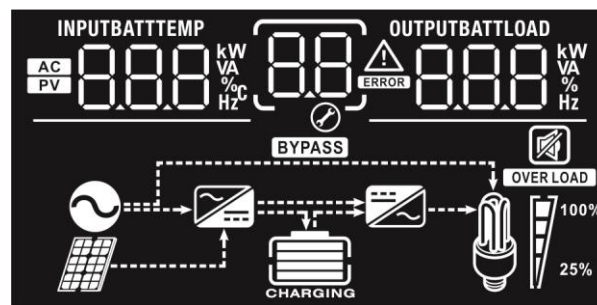

LED Indicator		Messages	
	Green	Solid On	Output is powered by utility in Line mode.
		Flashing	Output is powered by battery or PV in battery mode.
	Green	Solid On	Battery is fully charged.
		Flashing	Battery is charging.
	Red	Solid On	Fault occurs in the inverter.
		Flashing	Warning condition occurs in the inverter.





















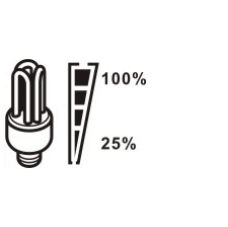

Function Keys

Function Key		Description
	ESC	To exit setting mode
	SCROLL	To go to next selection
	ENTER	To confirm the selection in setting mode or enter setting mode

LCD Display Icons

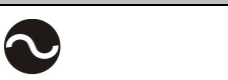

Icon	Function description
Input Source Information	
	Indicates the AC input.
	Indicates the PV input
INPUTBATT 	Indicate input voltage, input frequency, PV voltage, charger current, charger power, battery voltage.
Configuration Program and Fault Information	
	Indicates the setting programs.
	Indicates the warning and fault codes.
	Warning:  flashing with warning code. Fault:  lighting with fault code
Output Information	
OUTPUTBATTLOAD 	Indicate output voltage, output frequency, load percent, load in VA, load in Watt and discharging current.
Battery Information	

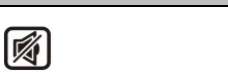
	Indicates battery SOC level by 0-24%, 25-49%, 50-74% and 75-100% in battery mode and charging status in line mode.																									
In AC mode, it will present battery charging status.																										
<table border="1"> <tr> <th>Status</th> <th>Battery voltage</th> <th colspan="3">LCD Display</th> </tr> <tr> <td rowspan="4">Constant Current mode / Constant Voltage mode</td> <td><25% SOC</td> <td colspan="3">4 bars will flash in turns.</td> </tr> <tr> <td>25% ~ 50% SOC</td> <td colspan="3">Bottom bar will be on and the other three bars will flash in turns.</td> </tr> <tr> <td>50% ~ 75% SOC</td> <td colspan="3">Bottom two bars will be on and the other two bars will flash in turns.</td> </tr> <tr> <td>> 75% SOC</td> <td colspan="3">Bottom three bars will be on and the top bar will flash.</td> </tr> </table>	Status	Battery voltage	LCD Display			Constant Current mode / Constant Voltage mode	<25% SOC	4 bars will flash in turns.			25% ~ 50% SOC	Bottom bar will be on and the other three bars will flash in turns.			50% ~ 75% SOC	Bottom two bars will be on and the other two bars will flash in turns.			> 75% SOC	Bottom three bars will be on and the top bar will flash.						
Status	Battery voltage	LCD Display																								
Constant Current mode / Constant Voltage mode	<25% SOC	4 bars will flash in turns.																								
	25% ~ 50% SOC	Bottom bar will be on and the other three bars will flash in turns.																								
	50% ~ 75% SOC	Bottom two bars will be on and the other two bars will flash in turns.																								
	> 75% SOC	Bottom three bars will be on and the top bar will flash.																								
Floating mode. Batteries are fully charged.		4 bars will be on.																								
In battery mode, it will present battery capacity.																										
<table border="1"> <tr> <th>Working Mode</th> <th>Battery Voltage</th> <th colspan="3">LCD Display</th> </tr> <tr> <td rowspan="4">Battery mode</td> <td><25% SOC</td> <td colspan="3"></td> </tr> <tr> <td>25% ~ 50% SOC</td> <td colspan="3"></td> </tr> <tr> <td>50% ~ 75% SOC</td> <td colspan="3"></td> </tr> <tr> <td>> 75% SOC</td> <td colspan="3"></td> </tr> </table>	Working Mode	Battery Voltage	LCD Display			Battery mode	<25% SOC				25% ~ 50% SOC				50% ~ 75% SOC				> 75% SOC							
Working Mode	Battery Voltage	LCD Display																								
Battery mode	<25% SOC																									
	25% ~ 50% SOC																									
	50% ~ 75% SOC																									
	> 75% SOC																									
Load Information																										
	Indicates overload.																									
	Indicates the load level by 0-24%, 25-49%, 50-74% and 75-100%.																									
0%~24%		25%~49%	50%~74%	75%~100%																						
																										
Mode Operation Information																										
	Indicates unit connects to the mains.																									
	Indicates unit connects to the PV panel.																									
	Indicates load is supplied by utility power.																									
	Indicates the utility charger circuit is working.																									
	Indicates the DC/AC inverter circuit is working.																									
Mute Operation																										
	Indicates unit alarm is disabled.																									

LCD Setting

After pressing and holding ENTER button for 3 seconds, the unit will enter setting mode. Press "UP" or "DOWN" button to select setting programs. And then, press "ENTER" button to confirm the selection or ESC button to exit.

Setting Programs:

Program	Description	Selectable option	
00	Exit setting mode	Escape 00 ESC	
01	Output source priority: To configure load power source priority	Utility first (default) 01 UTI	Utility will provide power to the loads as first priority. Solar and battery energy will provide power to the loads only when utility power is not available.
		Solar first 01 SOL	Solar energy provides power to the loads as first priority. If solar energy is not sufficient to power all connected loads, Utility energy will supply power to the loads at the same time.
		SBU priority 01 SBU	Solar energy provides power to the loads as first priority. If solar energy is not sufficient to power all connected loads, battery energy will supply power to the loads at the same time. Utility provides power to the loads only when battery voltage drops to either low-level warning voltage or the setting point in program 12.
02	Maximum charging current: To configure total charging current for solar and utility chargers. (Max. charging current = utility charging current + solar charging current)	10A 02 10 ^A	15A (default) 02 15 ^A
		20A 02 20 ^A	30A 02 30 ^A
03	AC input voltage range	Appliances (default) 03 APL	If selected, acceptable AC input voltage range will be within 90-280VAC.
		UPS 03 UPS	If selected, acceptable AC input voltage range will be within 170-280VAC.

06	Auto restart when overload occurs	Restart disable (default) 06 LFD	Restart enable 06 LFE
07	Auto restart when over temperature occurs	Restart disable (default) 07 LFD	Restart enable 07 LFE
09	Output frequency	50Hz (default) 09 50 Hz	60Hz 09 60 Hz
10	Output voltage	220V 10 220 ^v	230V (default) 10 230 ^v
		240V 10 240 ^v	
11	Maximum utility charging current Note: If setting value in program 02 is smaller than that in program in 11, the inverter will apply charging current from program 02 for utility charger.	2A 11 2 ^A	10A 11 10 ^A
		15A (default) 11 15 ^A	20A 11 20 ^A
		30A 11 30 ^A	
12	Setting SOC point back to utility source when selecting "SBU priority" or "Solar first" in program 01.	SOC 30% (default) 12 BATT 30%	Adjustable range is from 10% to 90%. Increment of each click is 1%.
13	Setting SOC point back to battery mode when selecting "SBU priority" or "Solar first" in program 01.	SOC 80% (default) 13 BATT 80%	Adjustable range is from 50% to 100%. Increment of each click is 1%.

16	Charger source priority: To configure charger source priority	If this inverter/charger is working in Line, Standby or Fault mode, charger source can be programmed as below:	
		Solar first 16 CS0	Solar energy will charge battery as first priority. Utility will charge battery only when solar energy is not available.
		Solar and Utility (default) 16 SNU	Solar energy and utility will charge battery at the same time.
		Only Solar 16 OS0	Solar energy will be the only charger source no matter utility is available or not.
		If this inverter/charger is working in Battery mode, only solar energy can charge battery. Solar energy will charge battery if it's available and sufficient.	
18	Alarm control	Alarm on (default) 18 BON	Alarm off 18 BOF
19	Auto return to default display screen	Return to default display screen (default) 19 ESP	If selected, no matter how users switch display screen, it will automatically return to default display screen (Input voltage /output voltage) after no button is pressed for 1 minute.
		Stay at latest screen 19 FEP	If selected, the display screen will stay at latest screen user finally switches.
20	Backlight control	Backlight on (default) 20 LON	Backlight off 20 LOF
22	Beeps while primary source is interrupted	Alarm on (default) 22 AON	Alarm off 22 AOF
23	Overload bypass: When enabled, the unit will transfer to line mode if overload occurs in battery mode.	Bypass disable (default) 23 BYD	Bypass enable 23 BYE
25	Record Fault code	Record enable (default) 25 FEN	Record disable 25 FDS
29	Low Battery cut-off point	SOC 10% (default) CO4 29	Adjustable range is from 10% to 50%. Increment of each click is 1%. BATT 10%



Display Setting

The LCD display information will be switched in turns by pressing "UP" or "DOWN" key. The selectable information is switched as following order in listed table.

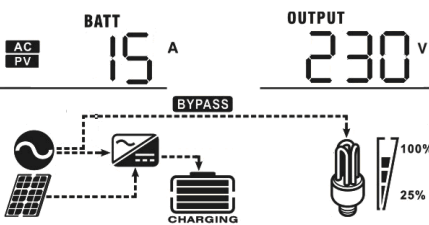
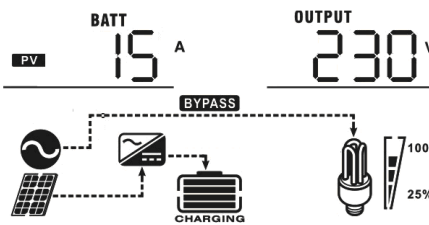
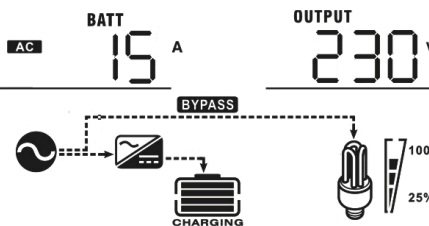
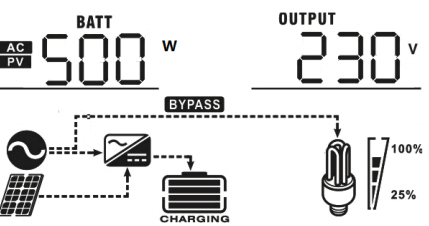
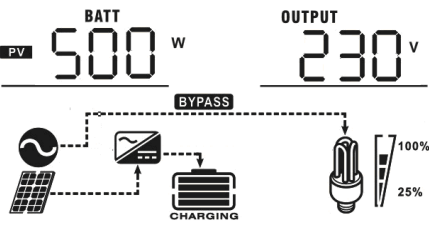
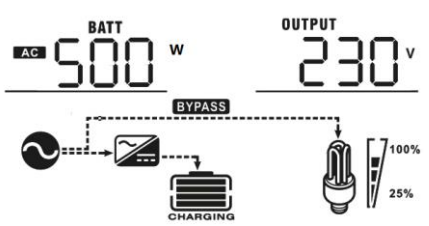
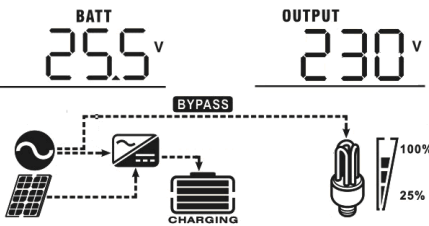

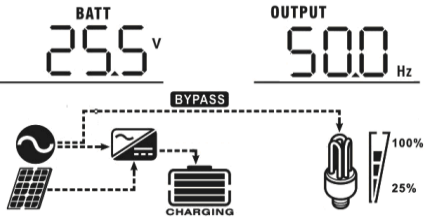
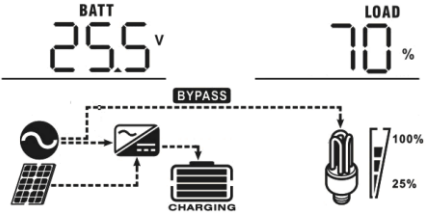
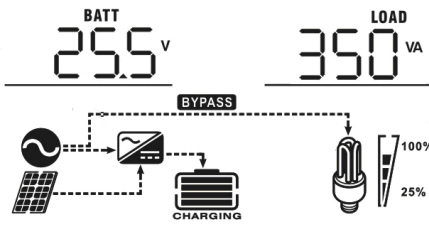
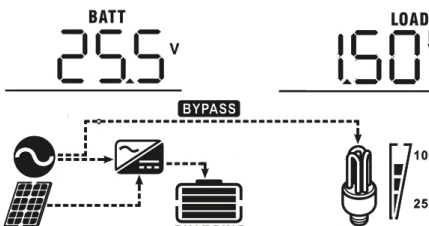
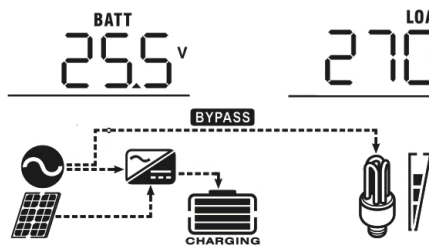
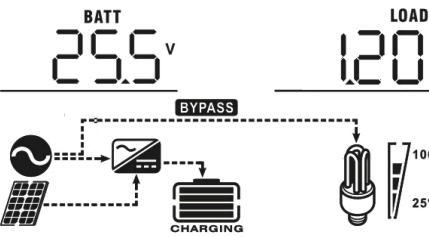

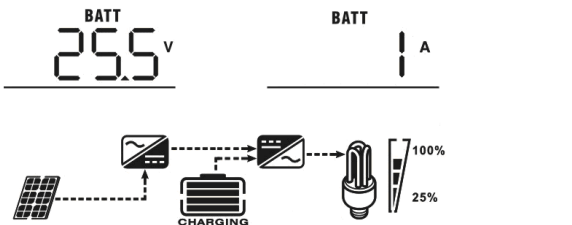

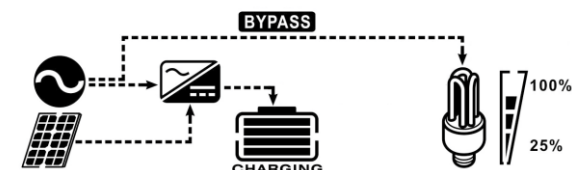
Selectable information	LCD display
Input voltage/Output voltage (Default Display Screen)	Input Voltage=230V, output voltage=230V
Input frequency	Input frequency=50Hz
PV voltage	PV voltage=260V
PV current	PV current = 2.5A
PV power	PV power = 500W



Charging current	<p>AC and PV charging current=15A</p>  <p>PV charging current=15A</p>  <p>AC charging current=15A</p> 
Charging power	<p>AC and PV charging power=500W</p>  <p>PV charging power=500W</p>  <p>AC charging power=500W</p> 
Battery voltage and output voltage	<p>Battery voltage=25.5V, output voltage=230V</p> 

Output frequency	<p>Output frequency=50Hz</p> 
Load percentage	<p>Load percent=70%</p> 
Load in VA	<p>When connected load is lower than 1kVA, load in VA will present xxxVA like below chart.</p>  <p>When load is larger than 1kVA ($\geq 1\text{kVA}$), load in VA will present x.xkVA like below chart.</p> 
Load in Watt	<p>When load is lower than 1kW, load in W will present xxxW like below chart.</p>  <p>When load is larger than 1kW ($\geq 1\text{kW}$), load in W will present x.xkW like below chart.</p> 

Battery voltage/DC discharging current	<p>Battery voltage=25.5V, discharging current=1A</p> 
Main CPU version checking	<p>Main CPU version 00014.04</p> 
Secondary CPU version checking.	<p>Secondary CPU version 00001.00</p> 





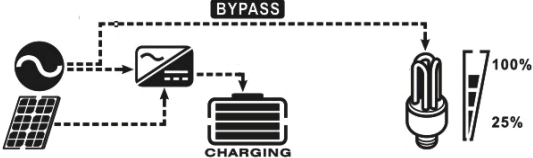
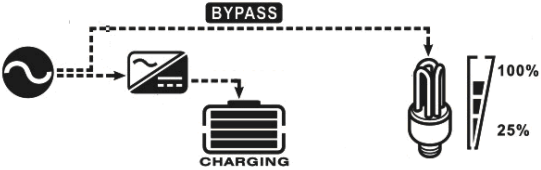
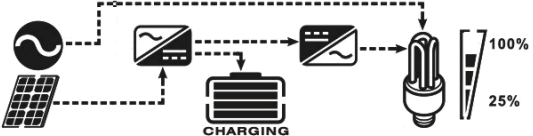
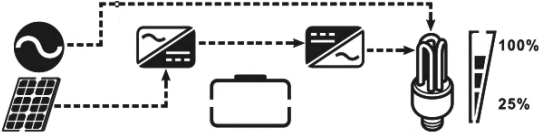
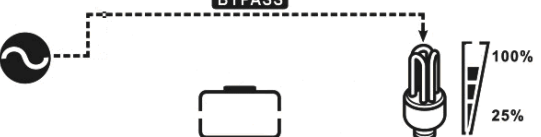

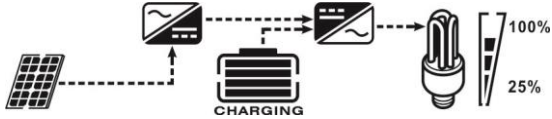
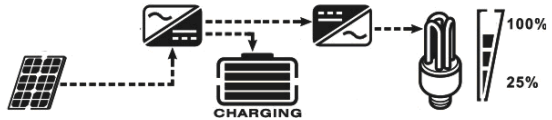
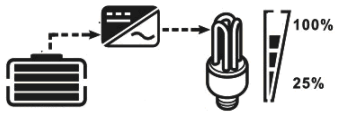
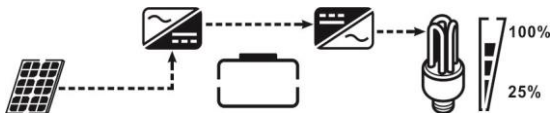







Operating Mode Description

Operation mode	Description	LCD display
<p>Standby mode</p> <p>Note:</p> <p>*Standby mode: The inverter is not turned on yet but at this time, the inverter can charge battery without AC output.</p>	<p>No output is supplied by the unit but it still can charge batteries.</p>	<p>Charging by utility and PV energy.</p>  <p>Charging by utility.</p>  <p>Charging by PV energy.</p>  <p>No charging.</p> 
<p>Fault mode</p> <p>Note:</p> <p>*Fault mode: Errors are caused by inside circuit error or external reasons such as over temperature, output short circuited and so on.</p>	<p>PV energy and utility can charge batteries.</p>	<p>Charging by utility and PV energy.</p>  <p>Charging by utility.</p> 

Operation mode	Description	LCD display
Fault mode Note: *Fault mode: Errors are caused by inside circuit error or external reasons such as over temperature, output short circuited and so on.	PV energy and utility can charge batteries.	Charging by PV energy. 
		No charging. 
Line Mode	The unit will provide output power from the mains. It will also charge the battery at line mode.	Charging by utility and PV energy. 
		Charging by utility. 
		If "solar first" is selected as output source priority and solar energy is not sufficient to provide the load, solar energy and the utility will provide the loads and charge the battery at the same time. 
		If "solar first" is selected as output source priority and battery is not connected, solar energy and the utility will provide the loads. 
		Power from utility. 

Operation mode	Description	LCD display
Battery Mode	The unit will provide output power from battery and PV power.	Power from battery and PV energy. 
		PV energy will supply power to the loads and charge battery at the same time. 
		Power from battery only. 
		Power from PV energy only. 

Fault Reference Code

Fault Code	Fault Event	Icon on
01	Fan is locked when inverter is off.	
02	Over temperature or NTC is not connected well.	
03	Battery voltage is too high	
04	Battery voltage is too low	
05	Output short circuited or over temperature is detected by internal converter components.	
06	Output voltage is too high.	
07	Overload time out	
08	Bus voltage is too high	
09	Bus soft start failed	
41	Battery short circuited over 3 times	
42	Battery over charge current	
43	Battery over discharge current	
44	Battery over-temperature	
51	Over current or surge	
52	Bus voltage is too low	

53	Inverter soft start failed	
55	Over DC voltage in AC output	
57	Current sensor failed	
58	Output voltage is too low	
59	PV voltage is over limitation	

Warning Indicator

Warning Code	Warning Event	Audible Alarm	Icon flashing
01	Fan is locked when inverter is on.	Beep three times every second	
02	Over temperature	None	
03	Battery is over-charged	Beep once every second	
04	Low battery	Beep once every second	
07	Overload	Beep once every 0.5 second	
10	Output power derating	Beep twice every 3 seconds	
15	PV energy is low.	Beep twice every 3 seconds	
16	High AC input (>280VAC) during BUS soft start	None	
32	Communication failure between inverter and battery module	None	

5. CLEARANCE AND MAINTENANCE FOR ANTI-DUST KIT

Overview

Every unit is already installed with anti-dusk kit from factory. This kit keeps dusk from your product and increases product reliability in harsh environment.

Clearance and Maintenance

Step 1: Please loosen the screw in counterclockwise direction on two sides of the unit.

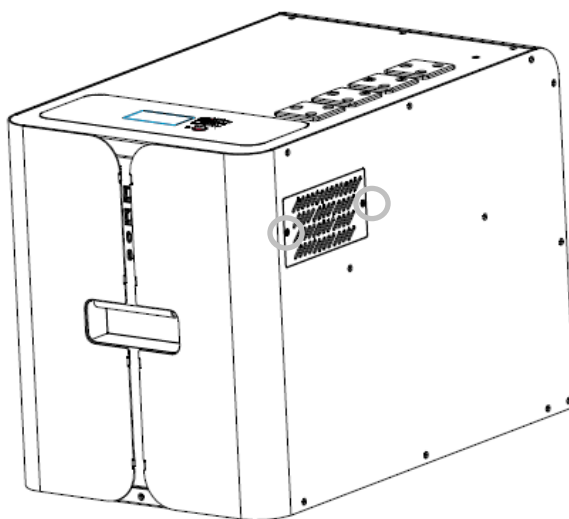

Step 2: Then, dustproof case can be removed and taken out air filter foam as shown in below chart.

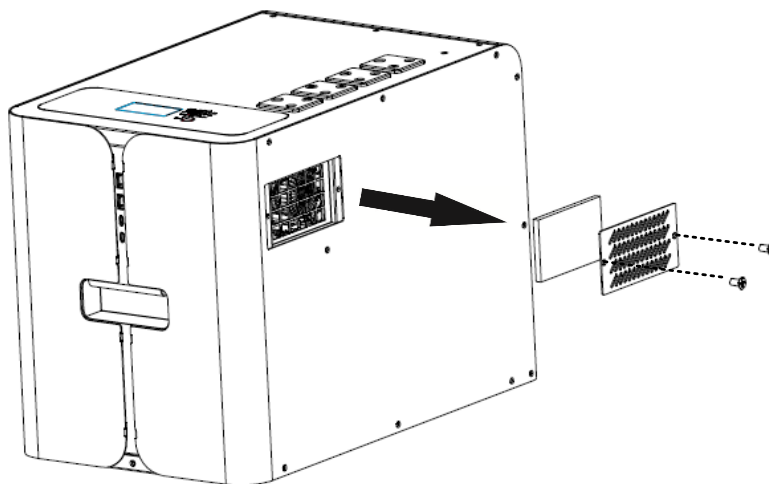

Step 3: Clean air filter foam and dustproof case. After clearance, re-assemble the dust-kit back to the unit.

NOTICE: The anti-dust kit should be cleaned from dust every one month.

6. SPECIFICATIONS

Table 1 Line Mode Specifications

MODEL	MF-MPS-1.2K	MF-MPS-2.5K
Input Voltage Waveform	Sinusoidal (utility or generator)	
Nominal Input Voltage	230Vac	
Low Loss Voltage	170Vac±7V (UPS); 90Vac±7V (Appliances)	
Low Loss Return Voltage	180Vac±7V (UPS); 100Vac±7V (Appliances)	
High Loss Voltage	280Vac±7V	
High Loss Return Voltage	270Vac±7V	
Max AC Input Voltage	300Vac	
Nominal Input Frequency	50Hz / 60Hz (Auto detection)	
Low Loss Frequency	40±1Hz	
Low Loss Return Frequency	42±1Hz	
High Loss Frequency	65±1Hz	
High Loss Return Frequency	63±1Hz	
Output Short Circuit Protection	Circuit Breaker	
Efficiency (Line Mode)	>95% (Rated R load, battery full charged)	
Transfer Time	10ms typical (UPS); 20ms typical (Appliances)	
<p>Output power derating: When AC input voltage drops to 170V, the output power will be derated.</p>	<p>The graph plots Output Power against Input Voltage. The y-axis represents Output Power, with two specific levels marked: 50% Power and Rated Power. The x-axis represents Input Voltage, with three key points marked: 90V, 170V, and 280V. The power curve starts at zero, rises vertically to 50% Power at 90V, then continues to rise linearly to reach Rated Power at 170V. From 170V to 280V, the output power remains constant at the Rated Power level. Beyond 280V, the output power drops to zero.</p>	

Table 2 Inverter Mode Specifications

MODEL	MF-MPS-1.2K	MF-MPS-2.5K
Rated Output Power	1.2KVA/ 1.2KW	2.5KVA/ 2.5KW
Output Voltage Waveform	Pure Sine Wave	
Output Voltage Regulation	230Vac±5%	
Output Frequency	50Hz	
Peak Efficiency	93%	
Overload Protection	5s@≥130% load; 10s@105%~130% load	
Surge Capacity	2* rated power for 5 seconds	
No Load Power Consumption	<35W	

Table 3 Battery Specifications

MODEL	MF-MPS-1.2K	MF-MPS-2.5K
Energy	768Wh	1536Wh
Nominal Voltage	25.6 VDC	51.2 VDC
Full Charge Voltage (FC)	28 VDC	56 VDC
Typical Capacity	30 Ah	
Max Continuous Discharging Current	60A	
Max Discharging Current	65A	
Protection	BMS	
Max Charge Current	30A (1C)	
Inner Resistance	≤0.6m ohm	
Lifecycle	≥2500 cycles, 0.5C charging/ discharging ≥50%@EOL 100% DoF	

Table 4 Charge Mode Specifications

MODEL	MF-MPS-1.2K	MF-MPS-2.5K
Utility Charging Mode		
AC Charging Current (Max)	30Amp (@ $V_{I/P}=230V_{ac}$)	
MPPT Solar Charging Mode		
Max. PV Array Power	2000W	3000W
Nominal PV Voltage	240Vdc	
Start-up Voltage	70Vdc +/- 10Vdc	
PV Array MPPT Voltage Range	60~300Vdc	60~400Vdc
Max. PV Array Open Circuit Voltage	350Vdc	450Vdc
Max. Input Current	10Amp	
Max Charging Current (AC charger plus solar charger)	30Amp	

Table 5 USB Output Specifications

MODEL	MF-MPS-1.2K	MF-MPS-2.5K
Type A Output	2PCS Supported with PD3.0 18W *2	
Type C Output	2PCS Supported with PD3.0 65W *2	

Table 6 General Specifications

MODEL	MF-MPS-1.2K	MF-MPS-2.5K
Safety Certification	CE, UN38.3	
Operating Temperature Range	-10°C to 50°C	
Storage temperature	-15°C~ 60°C	
Humidity	5% to 95% Relative Humidity (Non-condensing)	
Dimension (D*W*H), mm	450 x 280 x 330	
Net Weight, kg	20	25

7. TROUBLE SHOOTING

Problem	LCD/LED/Buzzer	Explanation / Possible cause	What to do
The inverter can't turn on from the battery mode	No any response when press the main SW on the top	1, The BMS had not turn on; 2, The battery had been deep full discharged	1. Turn on the BMS on the rear panel. 2. Recharge the battery from PV or grid.
No response after power on the BMS SW	No indication for the BMS LED	1. The battery voltage is far too low. (<2V/Cell) 2. BMS or battery cell failed	1. Re-charge battery. 2. Consult the local dealer for technical support.
Mains exist but the unit works in battery mode.	Input voltage is displayed as 0 on the LCD and green LED is flashing.	Input protector is tripped	Check if AC breaker is tripped and AC wiring is connected well.
	Green LED is flashing.	Insufficient quality of AC power. (Shore or Generator)	1. Check if AC wires are too thin and/or too long. 2. Check if generator (if applied) is working well or if input voltage range setting is correct. (UPS→Appliance)
	Green LED is flashing.	Set "Solar First" as the priority of output source.	Change output source priority to Utility first.
When the unit is turned on, internal relay is switched on and off repeatedly.	LCD display and LEDs are flashing	Battery is disconnected.	Check if battery wires are connected well.
Buzzer beeps continuously and red LED is on.	Fault code 07	Overload error. The inverter is overload 105% and time is up.	Reduce the connected load by switching off some equipment.
		If PV input voltage is higher than specification, the output power will be derated. At this time, if connected loads is higher than derated output power, it will cause overload.	Reduce the number of PV modules in series or the connected load.
	Fault code 05	Output short circuited.	Check if wiring is connected well and remove abnormal load.
		Temperature of internal converter component is over 120°C.	Check whether the air flow of the unit is blocked or whether the ambient temperature is too high.
	Fault code 02	Internal temperature of inverter component is over 100°C.	Check whether the air flow of the unit is blocked or whether the ambient temperature is too high.
	Fault code 03	Battery is over-charged.	Return to repair center.
		The battery voltage is too high.	Check if spec and quantity of batteries are meet requirements.
	Fault code 01	Fan fault	Replace the fan.
	Fault code 06/58	Output abnormal (Inverter voltage below than 190Vac or is higher than 260Vac)	1. Reduce the connected load. 2. Return to repair center
	Fault code 08/09/53/57	Internal components failed.	Return to repair center.
	Fault code 51	Over current or surge.	Restart the unit, if the error happens again, please return to repair center.
	Fault code 52	Bus voltage is too low.	
	Fault code 55	Output voltage is unbalanced.	
Fault code 59	PV input voltage is beyond the specification.	Reduce the number of PV modules in series.	
Fault code 32	Internal BMS communication had been loss	Check the internal com. cable between BMS board and main control board.	